

**Tower Crane / Grue à tour / Gru a torre
Grúa torre / Guindaste de torre**

Turmdrehkran 40 LC

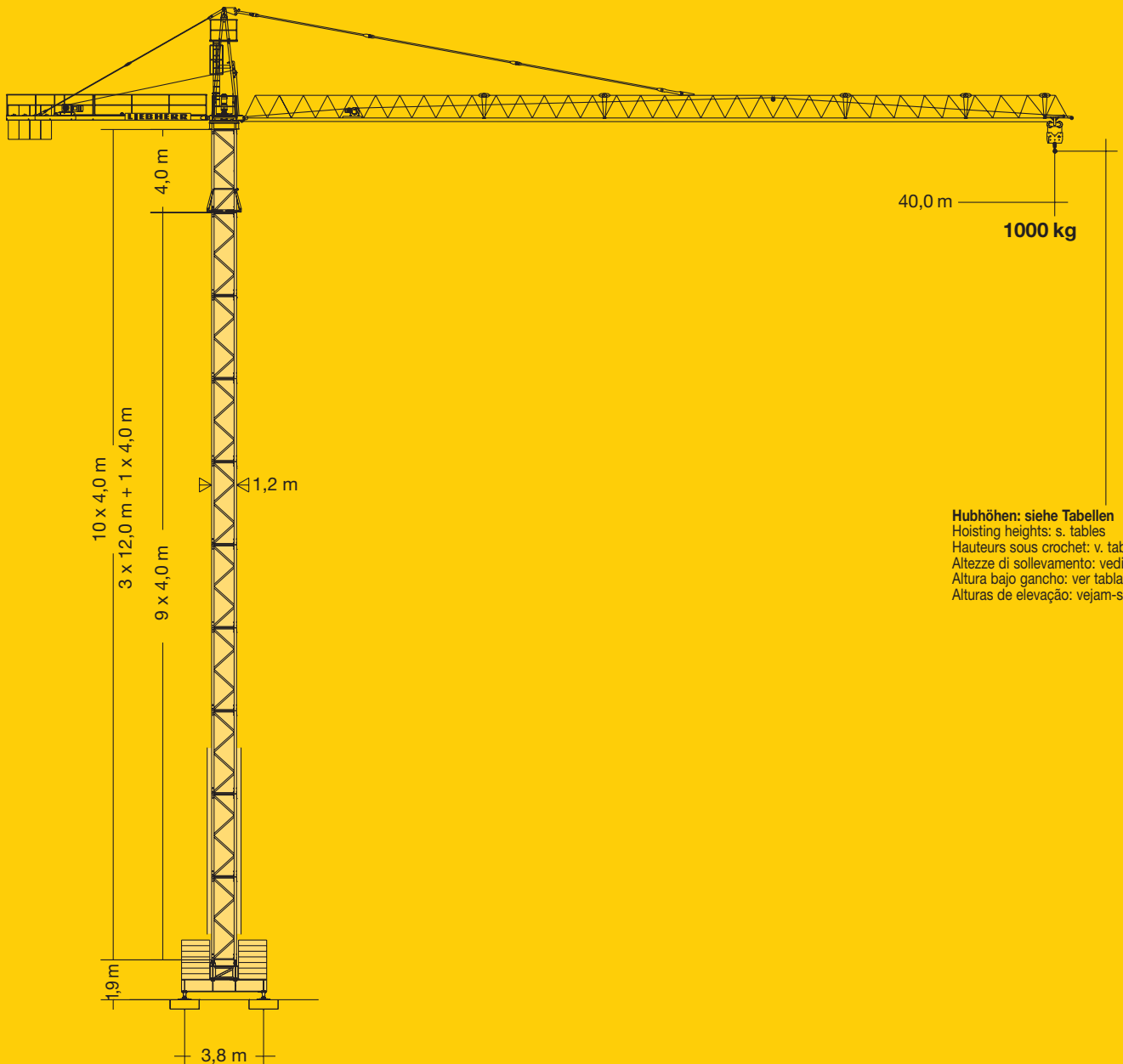

Hubhöhen: siehe Tabellen
Hoisting heights: s. tables
Hauteurs sous crochet: v. tableaux
Altezze di sollevamento: vedi le tabelle
Altura bajo gancho: ver tablas
Alturas de elevação: veja-se as tabelas

Turm 63 LC
tower / le mat
torre
max. 40,9 m

FEM

1 : 310

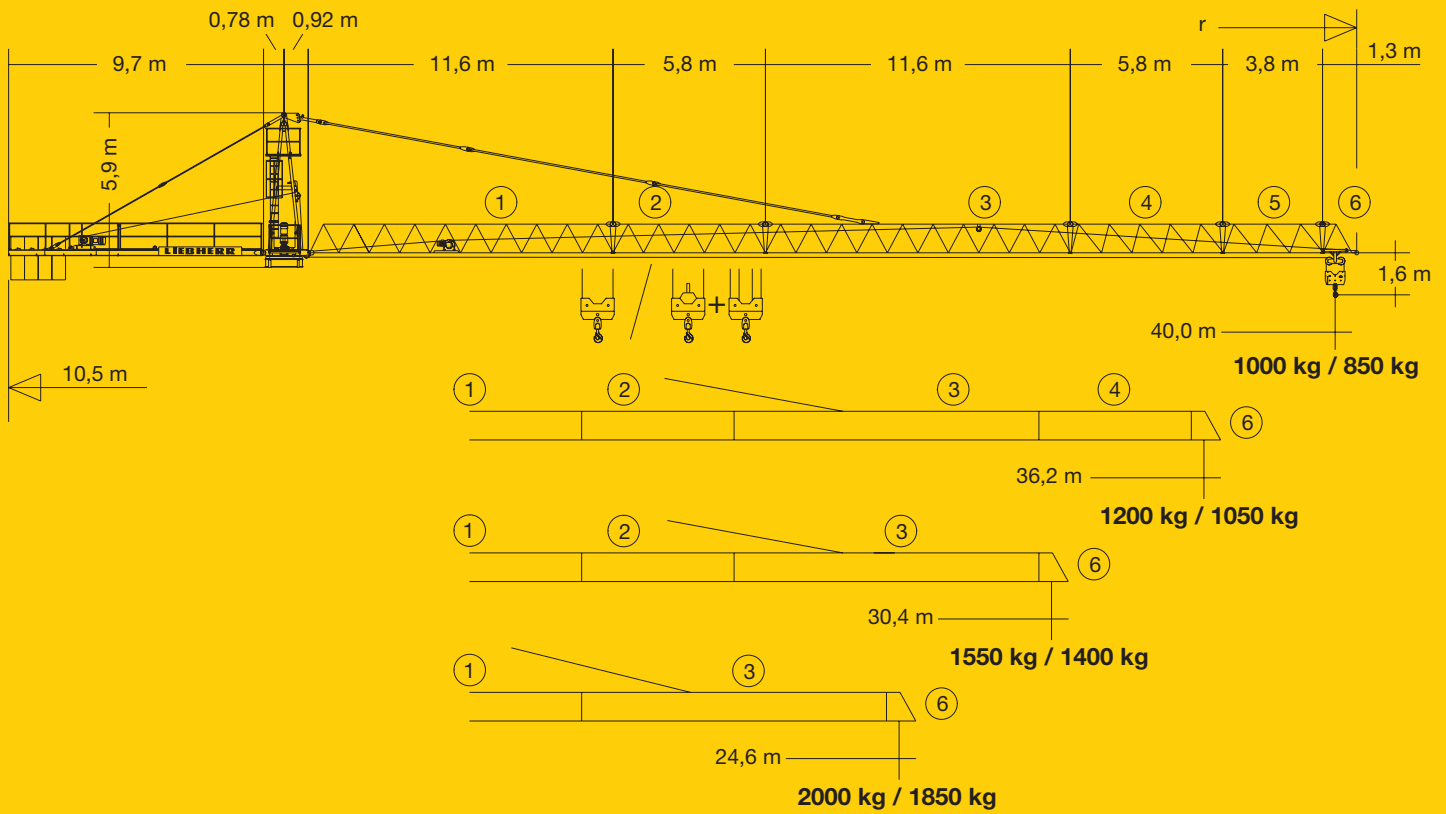

Gewicht

Weight / Poids / Peso / Peso / Pesos

Zentralballast / Central ballast Lest de base / Zavorra centrale Lastro central / Lastre central	50000 kg		(Ausl. 40 m)	6600 kg		19100 kg
--	----------	--	--------------	---------	--	----------

Hubhöhe

Hoisting height / Hauteur sous crochet / Altezza di sollevamento / Altura bajo gancho / Altura de montagem

		63 LC			
4 m	12 m				
10	3	-	40,9*	40,5*	39,3*
9	3	37,0*	36,9*	36,5*	35,3*
8		33,0	32,9	32,5	31,3
7		29,0	28,9	28,5	27,3
6	2	25,0	24,9	24,5	23,3
5		21,0	20,9	20,5	19,3
4		17,0	16,9	16,5	15,3
3	1	13,0	12,9	12,5	11,3
2		9,0	8,9	8,5	7,3
1		5,0	4,9	4,5	3,3
		m	m	m	m
		2,0 m	1,9 m	1,5 m	0,25 m
		3,80 m	3,80 m	3,80 m	

* Weitere Hubhöhen auf Anfrage. / Further hoist heights on request. / Hauteurs sous crochet sur demande. / Altre altezze di sollevamento: su richiesta. / Outras alturas de elevação: conforme ao pedido. / Para alturas bajo gancho superiores, consultar.

40 LC

Ausladung und Tragfähigkeit



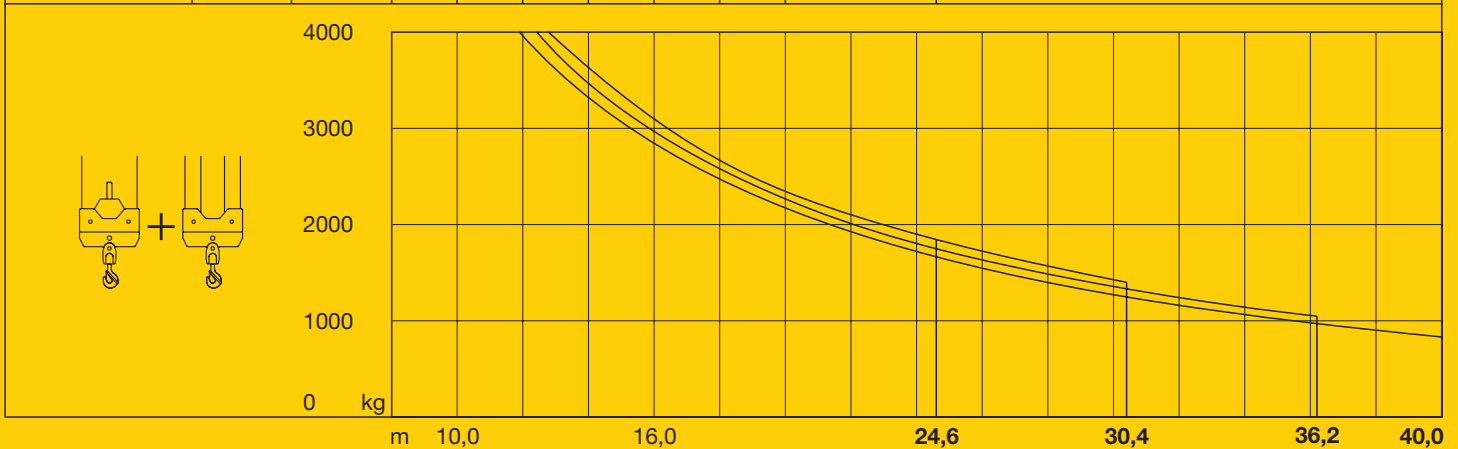

Radius and capacity / Portée et charge / Sbraccio e portata / Alcances y cargas / Alcance e capacidade de carga









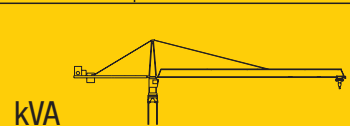

















m	r	m/kg	m/kg												
			10,0	12,0	14,0	16,0	18,0	20,0	24,6	27,0	30,4	33,0	36,2	40,0	
40,0	(r = 40,9)	2,1-22,6 2000							2000	1810	1620	1400	1270	1130	1000
36,2	(r = 37,1)	2,1-23,6 2000						2000	1900	1710	1480	1340	1200		
30,4	(r = 31,3)	2,1-24,5 2000						2000	1990	1780	1550				
24,6	(r = 25,5)	2,1-24,6 2000						2000	2000						
m	r	m/kg	m/kg												
			10,0	12,0	14,0	16,0	18,0	20,0	24,6	27,0	30,4	33,0	36,2	40,0	
40,0	(r = 40,9)	2,1-21,2 2000	2,1-11,9 4000	4000	3980	3310	2820	2440	2150	1660	1470	1250	1120	980	850
36,2	(r = 37,1)	2,1-22,2 2000	2,1-12,4 4000	4000	4000	3490	2970	2580	2270	1750	1560	1330	1190	1050	
30,4	(r = 31,3)	2,1-23,0 2000	2,1-12,7 4000	4000	4000	3630	3100	2690	2370	1850	1630	1400			
24,6	(r = 25,5)	2,1-23,1 2000	2,1-12,7 4000	4000	4000	3630	3100	2690	2370	1850					



Geschwindigkeiten

Speeds / Vitesses / Velocità / Velocidades / Velocidades

	U/min 0 - 0,8 sl./min tr./min	3,0 kW
	19,0 / 38,0 m/min 21,0 / 42,0 m/min	1,0 / 1,8 kW  1,5 / 3,0 kW 
	20,0 m/min	2 x 2,2 kW
	KVA	14,0 kW 22,0 kW 26,0 35,0

		Stufe / Step Cran / Marcia / Marcha / Marcha		kg	m/min
	3,2 / 14,0 / 14,0 kW 57,0 m LS-Trommel	4 Lagen Layers Couches Strati Camadas Capas	1 	2500 	2500 6,2
			2 	2500 	2500 27,0
			3 	1250 	1150 54,0
	90,0 m LS-Trommel	6 Lagen Layers Couches Strati Camadas Capas	1 	2400 	2300 6,5
			2 	2400 	2300 28,5
			3 	1150 	1050 57,0
	149,0 m LS-Trommel	5 Lagen Layers Couches Strati Camadas Capas	1 	2500 	2500 6,2
			2 	2500 	2500 28,0
			3 	1700 	1600 58,0
			1 	5000 	5000 3,1
			2 	5000 	5000 14,0
			3 	3500 	3500 29,0

Technische Daten

Technical data - Caractéristiques techniques

Caratteristiche tecniche - Características técnicas - Datos técnicos

Kolli-Liste

Packing List / Liste de colisage / Lista dei colli
Lista de embalagem / Lista de dimensiones y pesos

Montagegewichte: siehe Betriebsanweisung.
Erection weights: see instruction manual.
Poids de montage: voir manuel de service.
Pesi di montaggio: vedasi le istruzioni sull'uso.
Pesos de montagem: vejam-se as instruções p. uso.
Peso para el montaje: según manual.

Kranoberteil		Upper part of crane / Partie supérieure de grue Parte superiore della gru / Parte superior grúa Parte superior do guindaste	L (m)	B (m)	H (m)	kg	Einzelgewichte / Single weights / Poids individuels. Pesi di componenti. Pesos de peças componentes. Pesos unitarios.	
Pos. Item Rep Voce Ref Pos. 1	Anz. Qty. Qte. Qta. Quant. Cant. 1	Turmspitze mit Kud-Auflage Tower head section with slewing ring support Porte-flèche avec pivot / Testa porta-braccio con supporto ralla Cabeça de apoia de lança / Cabeza de torre con asiento de pista			5,57	1,86	1,73	2530
2	1	Gegenausleger / Counter-jib Contre-flèche / Contrabaccio Contra-lança / Contrapluma			9,79	1,46	0,36	960
3	1	Ausleger-Anlenkstück / Jib heel section Pied de flèche / Settore articolato di braccio Base articulada de lança / Pluma tramo primero			11,85	1,04	1,30	① 950
4	1	Ausleger-Zwischenstück / Intermediate jib section Elément intermédiaire de flèche / Spezzone di braccio Peça suplementar da lança / Tramo intermedio pluma			5,94 11,80 5,94 3,94	0,95 0,95 0,95 0,95	1,22 1,32 1,22 1,22	② 336 ③ 618 ④ 210 ⑤ 147
5	1	Ausleger-Kopfstück / Jib head Pointe de flèche / Punta freccia Cabeça de lança / Tramo punta de pluma			1,45	1,04	1,37	⑥ 80
6	1	Podeste / Platforms Plates-formes / Plattaforma Plataforma / Plataforma			1,21	0,33	0,77	66
7	1	Laufkatze / Trolley Chariot / Carrello Carrinho / Carrito			0,95	1,13	0,62	151
8	1	Unterflasche / Bottom Moufle / Bozzello Gancha / Potipasto			0,75	0,24	0,98	104
9	1	Hubwerk 11 kW / Winch Treuil / Argano / Mecanismo elevatoria Mecanismo elevación carga			1,25	1,23	0,55	440
Turm		Tower / Mât / Torre Torre / Torre						
10	1	Turmstück / Tower section Elément de mât / Elemento di torre Torre / Torre			12,0 m 4,0 m	12,27 4,27	1,20 1,20	2435 958
Klettereinrichtung		Climbing equipment / Equipement de télescopage / Attrezzatura per allungamento della gru Acessórios p. subida no edificio / Equipo de trepado						
11	1	Führungsstück kpl. / Guide section cpl. Cage télescopique cpl. / Gabbia di sopraelevazione compl. Peça de guia compl. / Torre de montaje completa			8,92	1,65	1,75	1890
12	1	KUD-Auflagenverlängerung / Slewing ring support extension Rehausse de pivot d'orientation / Prolunga supporto ralla Peça de guia / Prolongación asiento de pista			4,27	1,66	1,66	1120
13	1	Hydraulikanlage, Stütz- und Klettertraverse / Hydraulic unit, supporting and climbing cross members Système hydraul. avec traverses d'appui et de télescop. / Sist. idraul., traversa di appoggio e allugam. gru Instalação hidráulica, travessa de apoio e subida / Sistema hidráulico con traviesa de apoyo y trepado			4,86	0,95	0,70	580
Unterwagen		Undercarriage / Châssis / Carro della gru Carro de guindaste / Carreton						
14	1	Unterwagen-Rahmen / Undercarriage frame Cadre de châssis / Intelaiatura carro Estrutura do carrinho / Bastidor carretón			4,12	0,94	1,39	2575
15	2	Tragholm / Arm Longeron / Longherone Travessa / Brazo			4,10	0,30	0,60	935
16	2	Fahrschemel mit Antrieb / Rail bogie with drive Bogie moteur / Telajo con grúppa propulsore Quadra sem grúpa de propulsão / Caja rodillo motriz			0,78	0,84	0,53	297
17	2	Fahrschemel ohne Antrieb / Rail bogie without drive Bogie fou / Telajo senza grúppa propulsore Quadra com grúpa de propulsão / Caja rodillo conducido			0,66	0,30	0,51	204
18	-	Seile und Kleinteile / Small parts and ropes Accessoire et câbles / Accessori cavi Acessorios e cabos / Accesorios y cables			-	-	-	870

121 P – 3925 FEM (Section 1) Krangruppe A3 • 01.03 / 6

Konstruktionsänderungen vorbehalten! / Subject to alterations!
Sous réserves de modifications! / Si fa riserva di modifiche!
Salvo modificação da construçao! / Sujeto a modificaciones!

Printed in Germany.